

MS2603 - Sliding Door Deadbolt

MS2603

Mortice sliding deadbolt functions are operated by key outside and by turn snib or key inside. Locked by key or turnsnib when door is closed. For all deadbolt function options specify primary mortice lock e.g. MS2603SSS. This lock can then be easily adapted to suit the function required.

MS2603B

Mortice deadbolt functions are operated by key outside and by cylinder turn or turn snib inside. Locked by key or turnsnib when door is closed. Cylinder egress turns retract deadbolt in a downward motion.

Applications

Sliding Door Applications

Features

Stainless Steel case with stainless steel deadbolt, face plate and striker plate as standard. No handed components fully reversible.

Primary Lock MS2603 includes:

- 1 x Mortice lock body
- 1 x Deadbolt strike plate
- 2 x Cylinder retaining pins

Primary Lock MS2603B includes:

- 1 x Mortice lock body
- 1 x Deadbolt strike plate
- 2 x Cylinder retaining pins
- 1 x SA-KZ Turn Adaptor

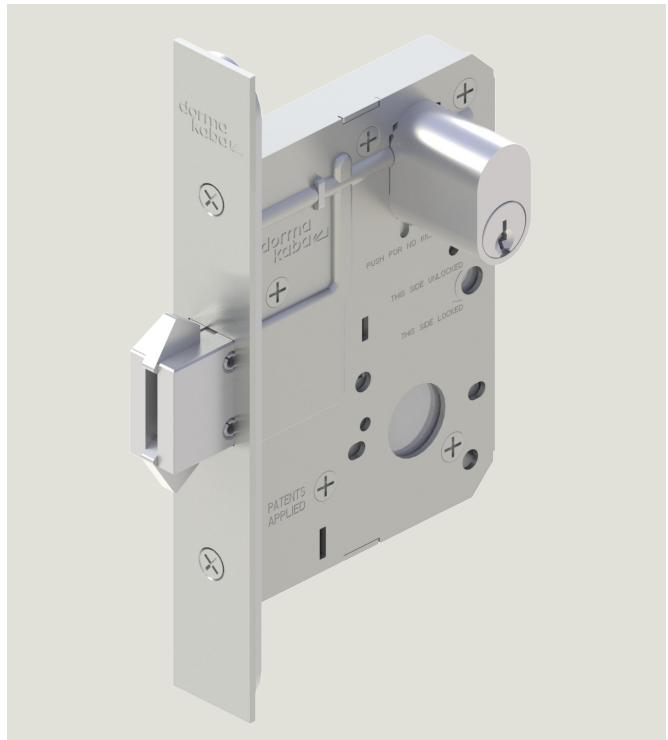





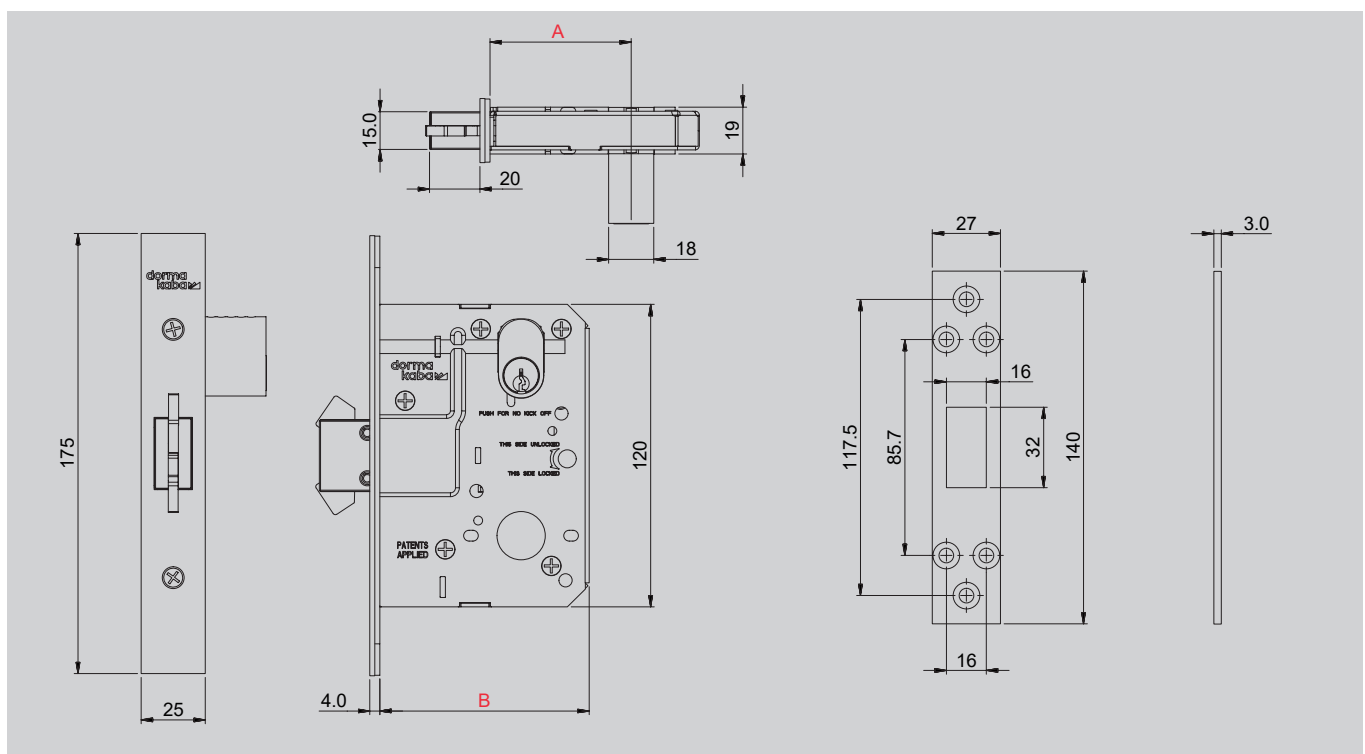



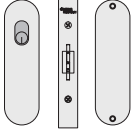

MS2603 & MS2903 Series Sliding Door Deadbolt Locks

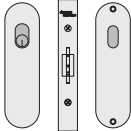
Model number	MS2603 & MS2603B	N/A
Dimension A	60mm	N/A
Dimension B	84mm	N/A

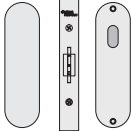

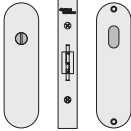
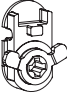
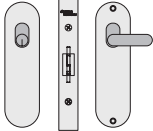
MS2603 Series Functions

Function Code	Description	Outside	Inside
MS2603 Deadbolt Functions			
MS2603KY 	Single Cylinder Deadbolt Hookbolt extended or retracted by key from outside only. Reversible.	KY 	
MS2603KYKY 	Double Cylinder Deadbolt Hookbolt extended or retracted by key from either side.	KY 	KY 
MS2603KWT 	Cylinder & Turn Deadbolt Hookbolt extended or retracted by key from outside or turn from inside.	KW 	SA-KY 
MS2603T 	Turn Deadbolt Hookbolt extended or retracted by turn from inside.		SA-KY 
MS2603B Deadbolt Functions			
MS2603BPT 	Privacy Deadbolt Hookbolt extended or retracted by turn from inside. Emergency unlocking from outside by slot or turn.		SA-KZ 
MS2603BKM-311KV 	Deadbolt - w/Cylinder Egress Turn Hookbolt extended or retracted by key from outside or egress turn inside. Note: MS2603B primary lock body is not used for this function.	KM 	KVL or KVR FA311 