

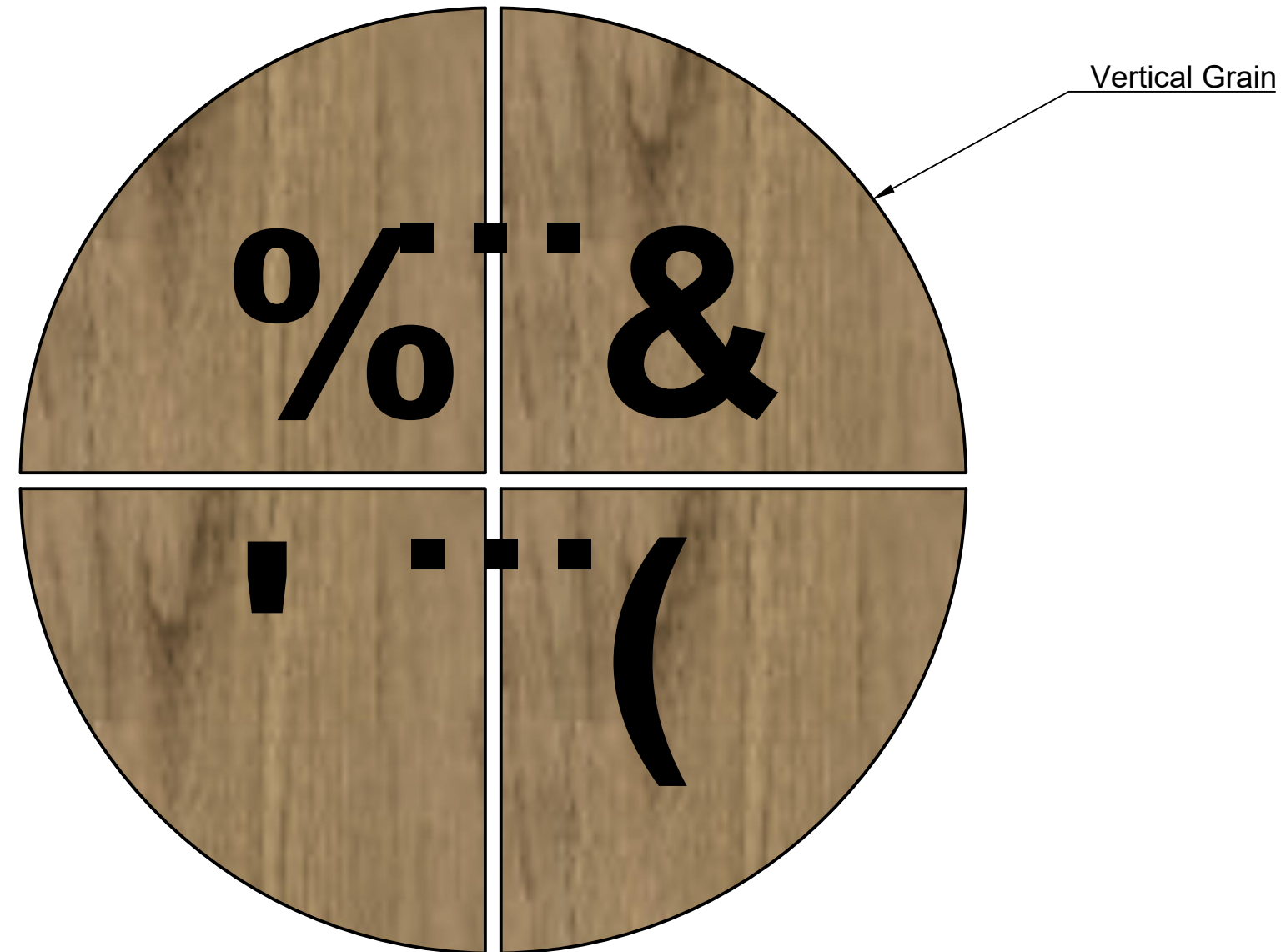

| | |
|--|--------------------|
|  StyleFinishDoorware | Drawing EHSFT10 |
| | Date 1/08/2023 |
| | Scale 1:2 |

Handing Specification

Looking from the outside of you door,
select from options 1, 2, 3, or 4.



| | |
|--|--------------------------------|
|  StyleFinishDoorware | Drawing T10 Handing Drawing |
| | Date 9/08/2023 |
| | Scale 1:2 |

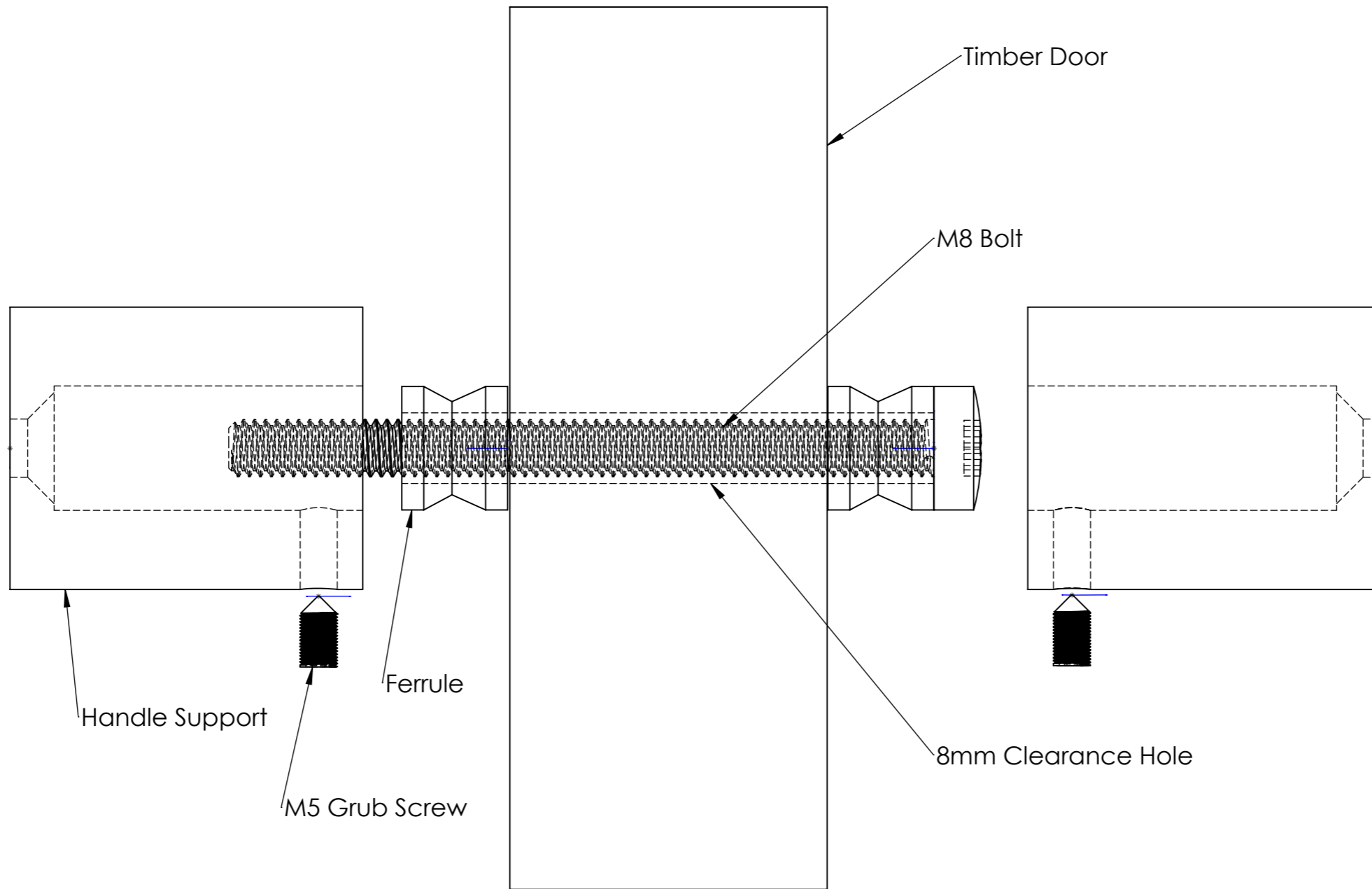

UNLESS OTHERWISE SPECIFIED: DIMENSIONS ARE IN MILLIMETERS



Drawing Name:
Back to Back Timber Fixing Assembly

Material:

Drawn By:
Chris McKenzie

| REVISION | Page | DATE |
|----------|------|------------|
| 1 | A3 | 23-06-2021 |

SCALE:1:0.6

SHEET 1 OF 1

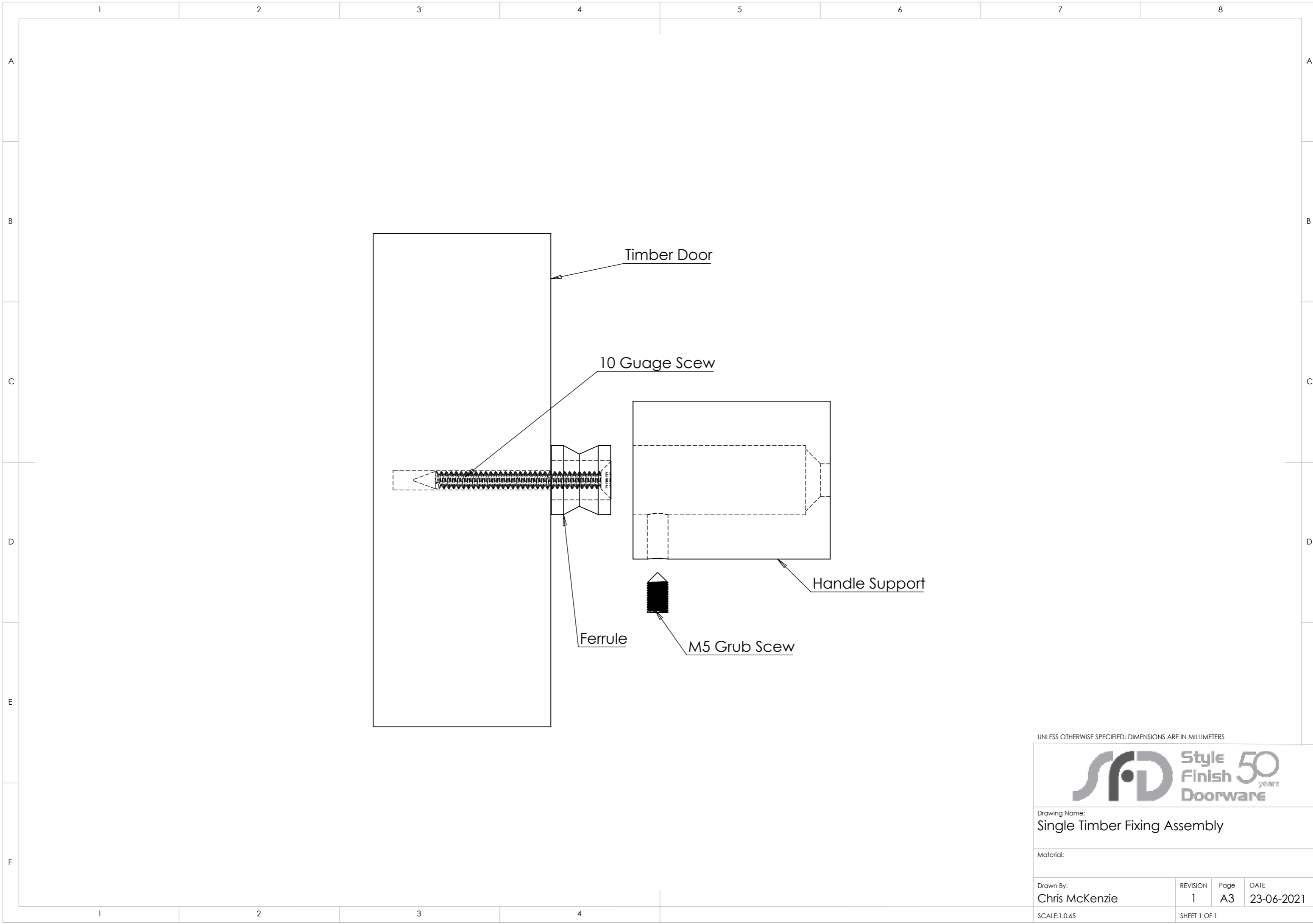

Timber Door

10 Gauge ScREW

Handle Support

Ferrule

M5 Grub ScREW

UNLESS OTHERWISE SPECIFIED: DIMENSIONS ARE IN MILLIMETERS



Drawing Name:
Single Timber Fixing Assembly

Material:

Drawn By:
Chris McKenzie

| | | |
|----------|------|------------|
| REVISION | Page | DATE |
| 1 | A3 | 23-06-2021 |

SCALE:1:0.65

SHEET 1 OF 1

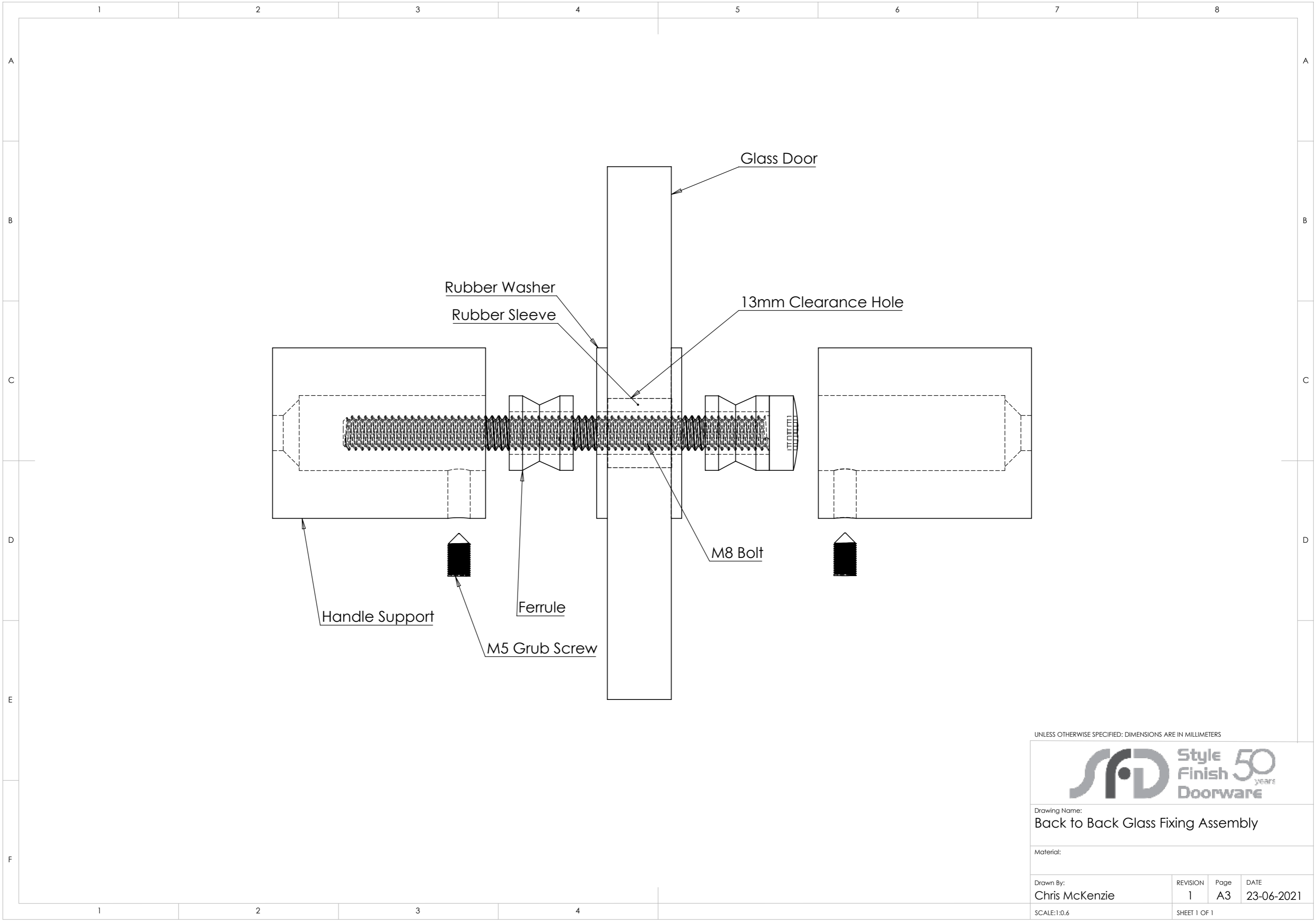

UNLESS OTHERWISE SPECIFIED: DIMENSIONS ARE IN MILLIMETERS



Drawing Name:
Back to Back Glass Fixing Assembly

Material:

Drawn By:
Chris McKenzie

| REVISION | Page | DATE |
|----------|------|------------|
| 1 | A3 | 23-06-2021 |

SCALE:1:0.6

SHEET 1 OF 1

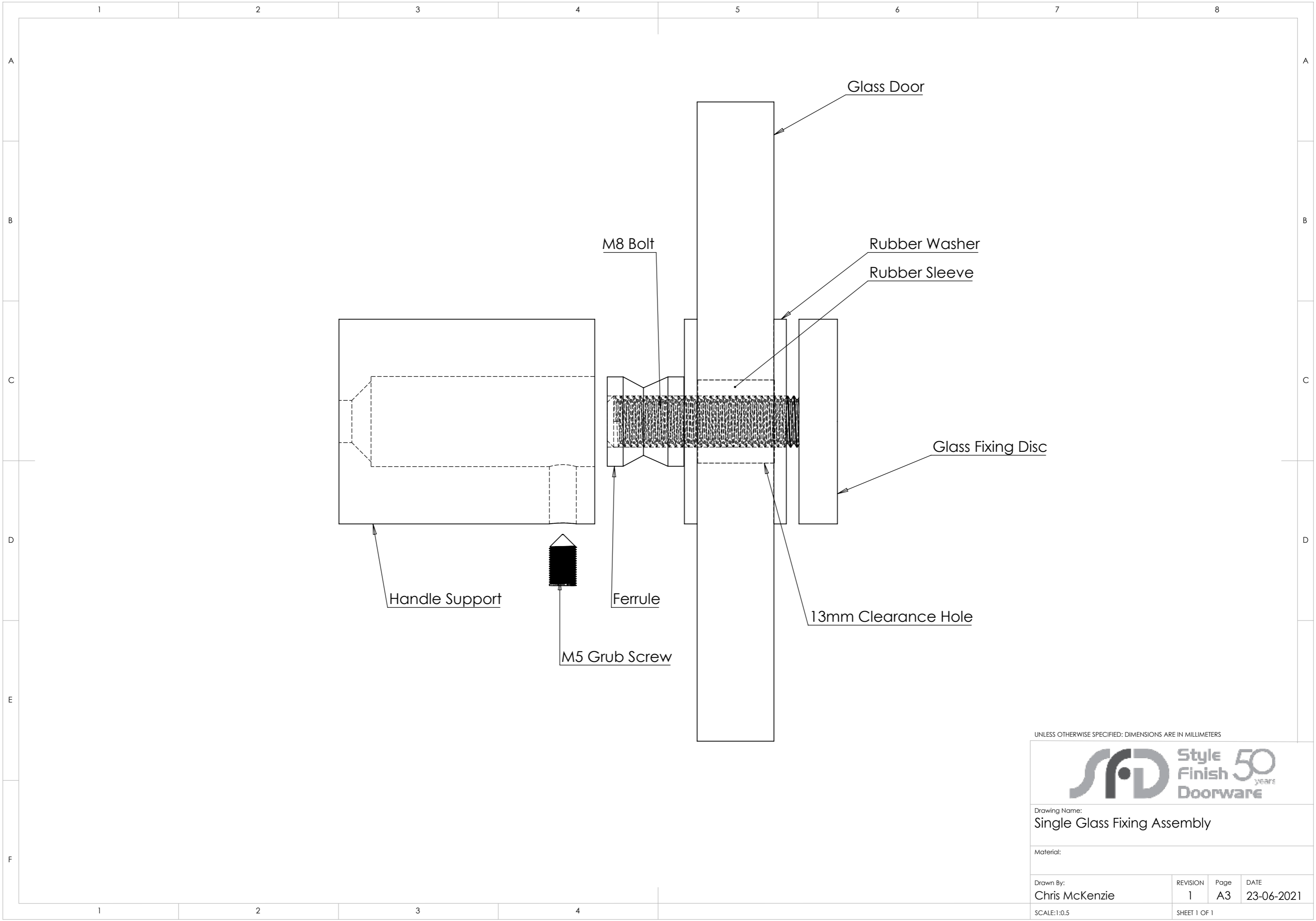

Glass Door

M8 Bolt

Rubber Washer

Rubber Sleeve

Glass Fixing Disc

Handle Support

Ferrule

13mm Clearance Hole

M5 Grub Screw

UNLESS OTHERWISE SPECIFIED: DIMENSIONS ARE IN MILLIMETERS



Drawing Name:
Single Glass Fixing Assembly

Material:

Drawn By:
Chris McKenzie

| | | |
|----------|------|------------|
| REVISION | Page | DATE |
| 1 | A3 | 23-06-2021 |

SCALE:1:0.5

SHEET 1 OF 1